

Maintenance/Operating Instructions

Part No.: 315 069 002 002
Issue 10.2010

Portable UPE for digital LOS of the Austrian Army with inbuilt mains rectifier and charged batteries

230VAC 50/60Hz / 24VDC 8A
20,4 to 28,8 VDC 2 × 8A
Part No.: UPE4000
Software-Version: 2.2
Date: December 2008



Copyright © 2010-2015
Nortec Electronics GmbH & Co. KG
An der Strusbek 32 B
D-22926 Ahrensburg
Tel: +49 / (0) 4102 / 42002
Fax: +49 / (0) 4102 / 42840
Email: info@nortec-electronics.de
www.nortec-electronics.de

Contents	
List of pictures	3
List of abbreviations	4
Procedure for updating operating instructions	5
Procedure for inserting additional pages	6
1. Description	7
1.1. General information	7
1.2. Technical description range of delivery	8
1.2.1. Name of device.....	8
1.2.2. NATO stock number	8
1.2.3. Supplier	8
1.3. Description of the functions	9
1.4. Range of application.....	9
1.5. Function with batteries.....	9
1.5.1. Battery Charging.....	11
1.5.2. Trickle Charge	11
1.5.3. Storage of UPE4000.....	12
1.5.4. Technical data UPE4000.....	15
1.5.5. Display and functional tests	16
1.6. Portable box LOWER part.....	16
1.6.1. Operating range.....	16
1.6.2. Electrical function	18
1.7. Portable box UPPER part.....	19
1.7.1. Operating range.....	19
1.7.2. Electrical functions.....	19
1.8. Display.....	22
1.8.1. Display without power supply line.....	22
1.8.2. Display with power supply line.....	22
2. Operation and maintenance	23
2.1. Start-up.....	23
2.2. Display of faults	23
2.3. Maintenance	24
2.4. Stop operation	24
2.5. Net not available.....	24
3. Maintenance and repair A1 and A2	25
3.1. Maintenance and repair Level A1	25
3.1.1. Repair Level A1 dust hood and fuse.....	25
3.1.2. Repair Level A1 feet of portable box	25
3.1.3. Repair Level A1 transportation handles.....	25
3.1.4. Repair Level A1 check batteries	25
3.1.5. Repair Level A1 change batteries.....	26
3.2. Additional repairs.....	27
3.3. Replacement of consumables, Level A2	27
3.3.1. Repair of connector External Charge	28
3.3.2. Replace fuse holder.....	29
3.3.3. Replace netcable.....	30
3.3.4. Replace power circuit breaker	31
3.3.5. Replace ventilation screw.....	32
3.3.6. Replace ground connector.....	33

4. Additional repair higher than Level A2 (depot and industry).....	33
4.1. Replace plug board	34
4.2. Repairs on the display PCB.....	35
4.2.1. Replace display board	35
4.2.2. Replace push-button	36
4.2.3. Change display.....	38
4.3. Replace power board	39
5. Spare parts.....	40
6. Documents	43

List of pictures

Pic. 1: USV type UPE4000	9
Pic. 2: USV type UPE4000, Block Circuit Diagram	10
Pic. 3: Typical charging curve of a partly charged battery.....	12
Pic. 4: USV Type UPE4000 , View from the TOP	13
Pic. 5: Portable box LOWER part without batteries view from top	17
Pic. 6: Portable box LOWER part without batteries view from the bottom	17
Pic. 7: PE-Connector within portable box LOWER part	18
Pic. 9: Portable box UPPER Part view from below	20
Pic. 10: Upper Part of device view inside.....	28
Pic. 11: Fuse holder.....	29
Pic. 12: Netcable.....	30
Pic. 13: LOWER part power circuit breaker	31
Pic. 14: UPPER part power circuit breaker	31
Pic. 15: Ventilation screw inside	32
Pic. 16: Ground connector screw.....	33
Pic. 17: Special Tool COT (Bernier).....	33
Pic. 18: RFE/BBE connector.....	33
Pic. 19: Plug board without connectors.....	34
Pic. 20: Plug board fixation	34
Pic. 21: Insulation tape on the rear side of the display.....	35
Pic. 22: Display board	36
Pic. 23: Constant voltage regulators	36
Pic. 24: Distance rolls	36
Pic. 25: Display	38
Pic. 26: Power board view from above.....	39
Pic. 27: Main electronic components on power board on heat sink	39

List of abbreviations

A	Ampere
AC	Alternating Current
Ah	Ampere hour
°C	degree Celsius
EMC	Electromagnetic compatibility
F	Fuse
Hz	Hertz
I	current
I ₅	Charging current which loads the battery within 5 hours
IEC	International Electrotechnic Committee
IP	Indice de Protection
kg	kilogram
mA	Milliampere
MIL STD	Military Standard
m	metre
mm	millimetre
mV	milliVolt
NSN	NATO Stock Number
OTAN	NATO Organisation du Traité Atlantique Nord
ptp	peak to peak, value for amplitude double
RAL	German institute for delivery specifications (Reichsausschuß für Lieferbedingungen)
TKZ	Part Number (TeileKennZeichen)
U	Voltage
UPS	Uninterruptible Power Supply
V	Volt
VG	Norm for defense devices (Verteidigungsgerätenorm)
VHF	Very High Frequency
W	Watt

Procedure for inserting additional pages

Principle:

Inserting a new page for the first time please add a letter of the middle of the alphabet to the page number. Inserting a new page for the second time please choose a letter of the middle of the remaining letters of the alphabet. Use this principle for every insertion.

Example:

The page to be inserted between page 14 and 15 gets the page number 14M.

The second and the third pages to be inserted will be numbered as follows.

The second page:

If the page has to be inserted before 14M it gets page number 14F.

If the page has to be inserted after 14M it gets page number 14U.

The third page:

Please use the following table to assign the page numbers.

No. of change	Letter																									
	A	B	C	D	E	F	G	H	J	K	L	M	N	P	R	S	T	U	V	W	X	Y	Z			
1												*														
2					*													*								
3			*						*						*						*					
4		*		*				*		*				*		*				*		*				
5	*				*		*				*		*				*		*				*			

1. Description

Portable power supply for Uninterruptible Supply of 24VDC – appliances with mains rectifier and charged batteries.

Mains voltage

230VAC 50/60Hz or 24VDC maximum 8A

Output voltage

20,4 to 28,8 VDC 2 × 8A

1.1. General information

The portable power supply 230VAC 50/60Hz or 24VDC maximum 8A with 24VDC maximum 2 × 8A output, further on named UPE4000 or just device is used by the Austrian army for power supply of LOS and for technical devices with 24V DC input. The power supply is possible

- by installed or mobile AC via connecting the UPE 4000 and
- if AC is not available via the built-in battery or via the vehicle battery which will be connected to the UPE4000 or via mobile fuel cells.

Usually the UPE4000 will be used with AC via public current.

After the battery is full the charger integrated in the UPE4000 uses trickle charging mode.

There is no time limit for leaving the integrated batteries on the net – they will not be damaged.

1.2. Technical description range of delivery

1.2.1. Name of device

Portable power supply for 24 VDC – appliances with built-in mains rectifier and charged batteries

230VAC 50/60Hz or 24VDC maximum 1 × 8A

20,4 to 28,8 VDC 2 × 8A

Including:

230V 50/60 Hz The device can be used with 230Voltage net.

28,8VDC 8A The device transforms the AC to DC (28,8 Voltage / 8A).

20,4VDC to 28,8VDC 2 × 8A

The device provides up to 8A DC from the integrated batteries or the externally connected parallel DC power supply. Upto 16A can be taken while using socket RFE/BBE and external Charge in addition.

1.2.2. NATO stock number

UPE

230VAC 50/60Hz / 28,8VDC 8A

20,4VDC to 28,8VDC 2 × 8A

Part No.: UPE4000

NATO stock number: t.b.d.

1.2.3. Supplier

Nortec Electronics GmbH & Co. KG

An der Strusbek 32 B

D-22926 Ahrensburg

Tel: +49 / (0) 4102 / 42002

Fax: +49 / (0) 4102 / 42840

Email: info@nortec-electronics.de

www.nortec-electronics.de

Hersteller Code C3410

1.3. Description of the functions

The following components are integrated in the portable box which is made of powder coated stainless steel.

Upper Part of the device with all electrical components

Lower Part of the device with batteries 2 × 12V 16Ah in series connection



Pic. 1: USV type UPE4000

The device is ready for use if at least a 230V net is connected or the batteries of the device have a voltage of more than 20,4 VDC.

1.4. Range of application

The UPE4000 has been developed for the use in open country. It complies with safety class IP54. It provides the connected consumers with DC – Input with the needed current either via AC - net or via external batteries connected in parallel. The batteries will reach the optimum charging capacity and stay charged if AC – net is available.

The digital LOS used by the Austrian Army:

BBE 4104 and

RFE 4142 as well as the users interface COT 4001

will not be influenced by the device. Mobile radios positioned next to the UPE4000 will not disturb the functions of the device.

1.5. Function with batteries

The device contains 2 maintenance-free GEL-batteries size 12V 16 Ah.

The batteries are connected by a low resistance copper bridge so that they form a 24V set.

The batteries are mounted shock-resistant in a foam-coated portable box.

The batteries secure the demanded autonomy time of at least 2 hours operation at a continuous load of 110 Watt with peaks up to 250 Watt.

For use over a longer period without net or generator connection connect additional battery packs of 24VDC nominal voltage or fuel cells to the socket „External Charge“ . These batteries will be connected in parallel to the built-in battery.

For start-up the fuel cells need external voltage therefore the socket „External Charge“ works in both directions. This means additional consumers can be connected to the socket. It is possible to charge empty external battery sets as well.

ATTENTION

This port is protected with 10A self resetting fuse. Do not connect larger consumers!

CAUTION

At any case do not use the power supply line of the charger if additional primary battery is connected (i.e. not rechargeable Lithium Ion Battery) because of explosion hazard.

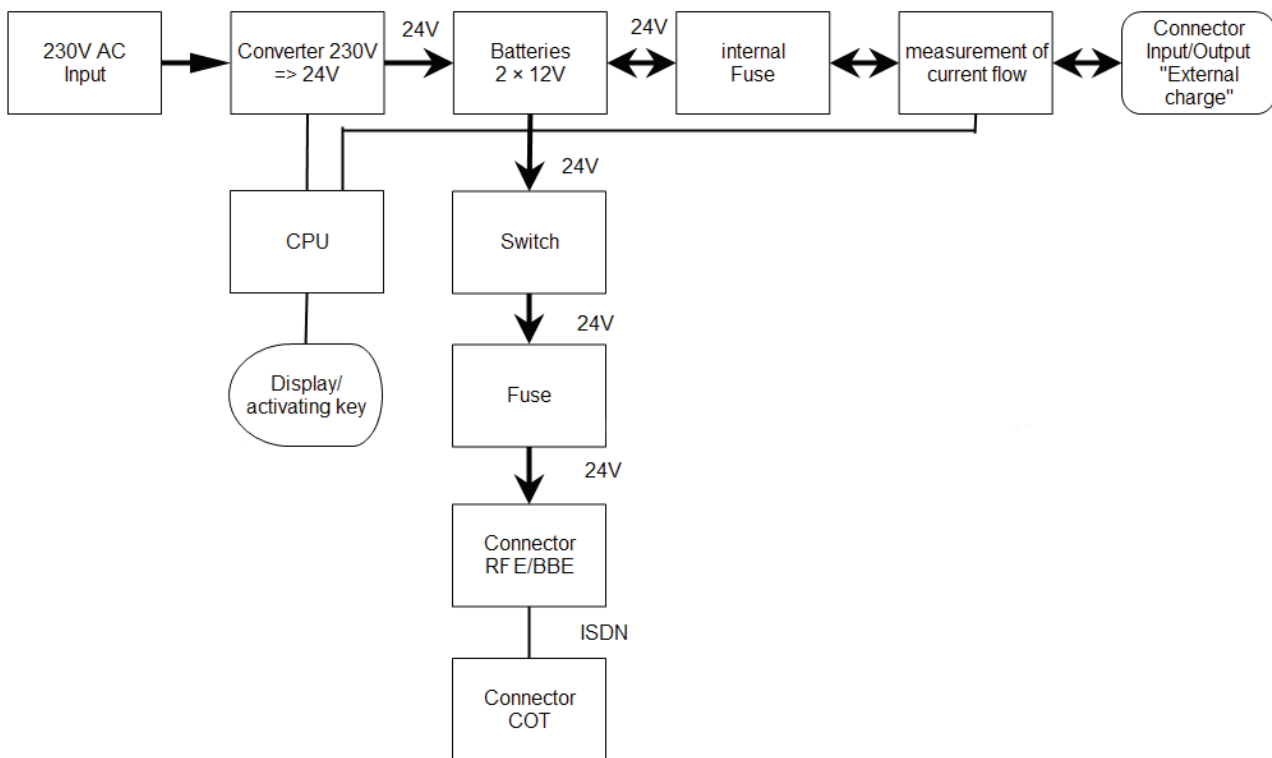

Pic. 2: USV type UPE4000, Block Circuit Diagram

1.5.1. Battery Charging

The general charging procedure is temperature compensated at 35mV per °C per cell. The following values understand at a ambient temperature of 20°C.

- Pre-charge with constant U of 28,8VDC up to the threshold of 8A charging current.
- Main Charge I-section with a constant I of 8A to the voltage maximum of 28,8VDC
- Main Charge U-section with constant voltage of 28,8V for 10h, until the charging current has declined to about 0,1A.

1.5.2. Trickle Charge

The phase of trickle charging starts immediately after the main charge section of the charging process. The unit waits, until the battery voltage has fallen down to the lower threshold of 25,4. The trickle charge current of 1A is switched on until the upper threshold of 28,2 has been reached. After switching off current the same process will be repeated. By this procedure a sufficient status of the battery-set is guaranteed. If the battery voltage goes under 25,4V for more than 60 seconds due to external consumers, the main charging process including trickle charge phase is initiated. Short removing of the plug from mains shows the same effect.

1.5.3. Storage of UPE4000

The power supply unit may be stored at values from -30°C up to $+50^{\circ}\text{C}$ without damages to be expected.

Storage duration for the unit and the batteries is different

If the storage time for the electronic device exceeds 10 years, capacitors may have reached their maximum lifetime. Correct function of the device should be verified by electronic specialists.

The batteries are subject to a permanent self-discharge rate, which depends on the ambient temperature. The battery supplier guarantees a storage time of 2 years at 20°C . At an increase of 10 degrees the storage time reduces down to one year. Further 10 degrees cause a storage period of 6 months. These values are reliable, if the storage time started with full batteries.

Remark

Never store a lead-acid battery under 12V. Due to deep discharge the battery will be destroyed by sulfatation of the plates. This process cannot be healed by charging. We recommend regular control of battery voltage by pressing key "DISPLAY". If voltage is low please connect the unit to mains.

Permanent connection to mains is uncritical.

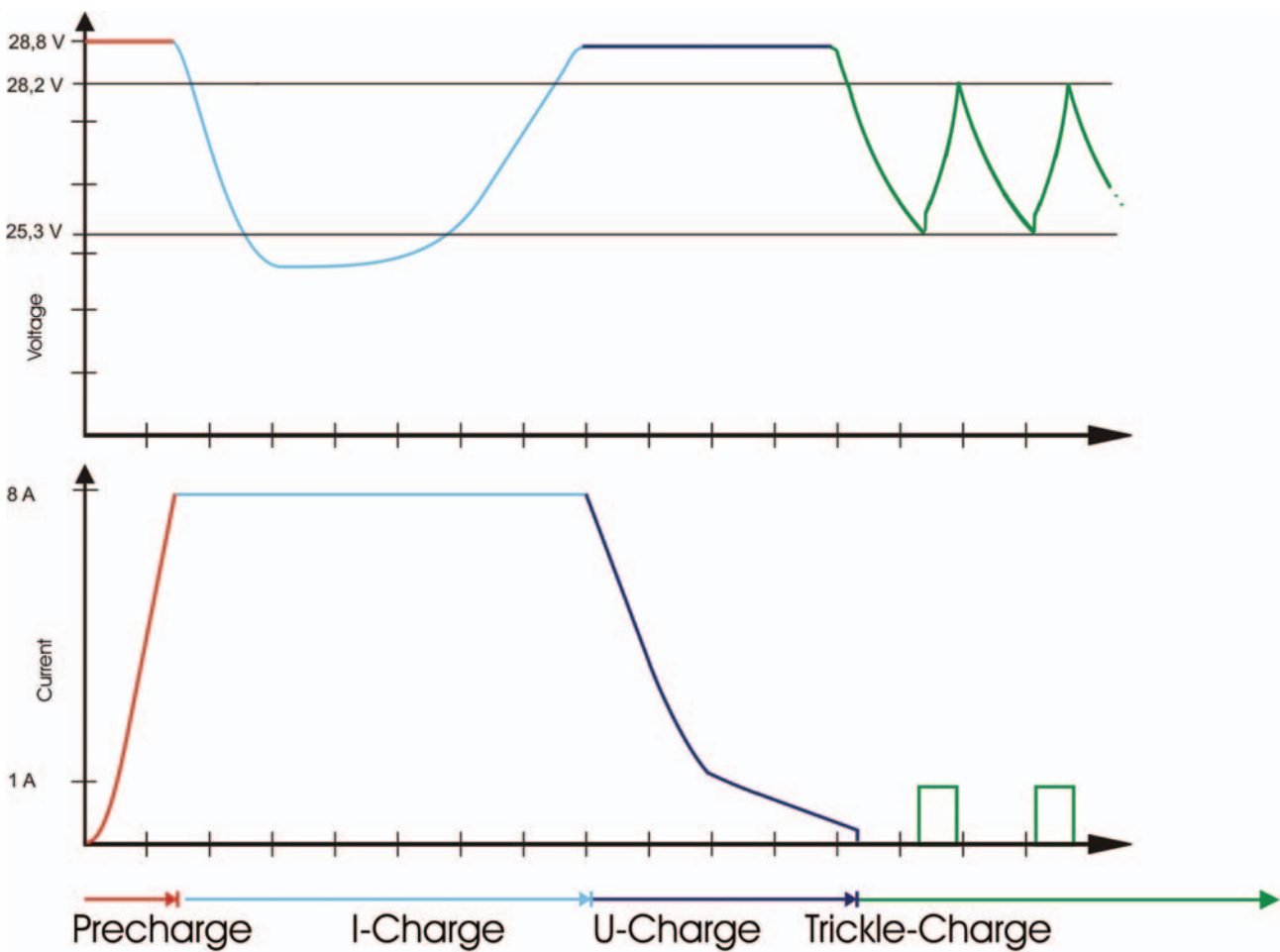

Pic. 3: Typical charging curve of a partly charged battery

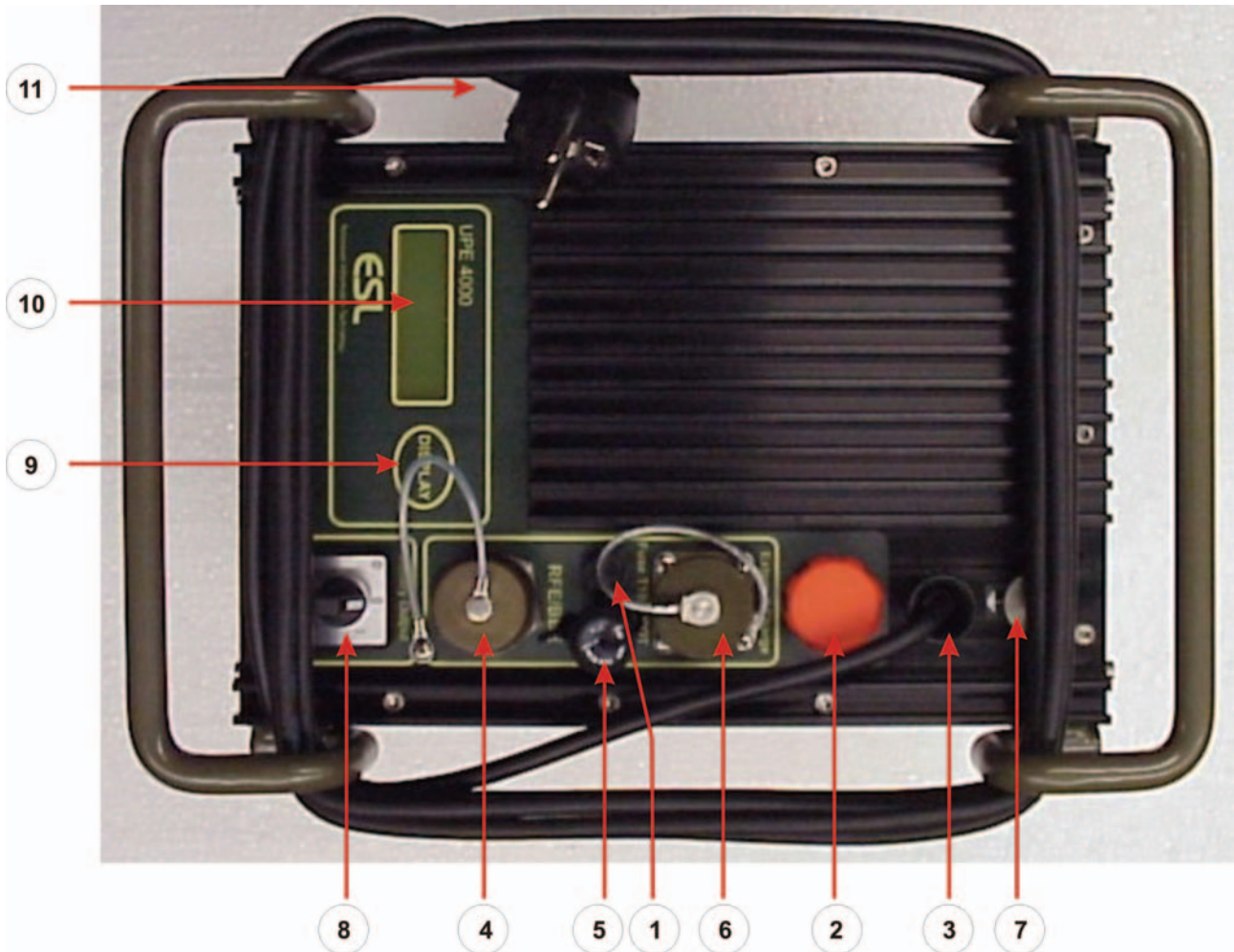

Pic. 4: USV Type UPE4000 , View from the TOP

The following security elements are on Upper Part of the device:

- (1) Safeguarding output RFE/BBE F2: T10A accessible from outside (Fuse T10A)
- (2) Ventilation element for conducting possible battery gas
- (3) Mains lead 5m with Schuko-plug (VDE, IEC)
- (4) Mobile radio RFE/BBE according to MIL-DTL-38999, Series III:
Amphenol number D38999/24WD97BN with dust cap
- (5) Control device COT Bernier CMA7N14Y8
- (6) DC-input/output-connector according to VG 95234, Cannon CA3102-E16S-4SB with dust cap
- (7) connecting screw for external ground connection (PE)
- (8) Power circuit breaker battery output on RFE/BBE
- (9) Display activating key
- (10) Display

The device will be connected as follows:

Using the plug (11) the UPE4000 uses AC-current 230V. Therefore enroll the mains lead from the transportation handles completely. The cable has got a common mains plug according to VDE / IEC.

At the socket (6) named „External Charge“ an additional battery or fuel cells with nominal voltage of 24VDC can be connected.

At the socket (4) named RFE/BBE the radio set will be connected.

The control device COT will be connected to the port (5).

The ground screw (7) will be connected to ground via earth lead of minimum 4mm², M5 gable cable shoe and a ground nail for protecting consumers against electrocute in case of short circuit / stroke of lightning.

Press the key (9) for information concerning charging state of the connected batteries.

By turning the power circuit breaker (10) to the right in position „On“ the supply voltage of the battery to the port RFE/BBE (6) will be released.

1.5.4. Technical data UPE4000

unit name	Portable UPE for digital radios
HTZ/TKZ / Part No.	UPE4000
NSN/NATO Stock Number	6130-41-000-5114
technical data	
type:	UPE4000
Part No.: Electronic	UPE4000
Colour	RAL 7013
measurements (LxBxH) in mm / size	330 x 220 x 325
weight incl. batteries	19,1 kg incl. Batteries
batteries	2 x Sonnenschein A512 / 16 G5
Time of autonomy at 110W continous load	
+20°C	136 Min
0°C	112 Min
-20°C	68 Min
net voltage:	230V ±10% / 45-65Hz
external charging connector:	U _{max} : 28,8V / I _{max} :8A
input power:	< 500VA (max.)
output power charging max.:	28,8 VDC ±1% (constant voltage)
output voltage discharged min.:	20,4 VDC +/- 1%
output voltage disconnect:	Power Switch 10A
output current main charging:	8A ±5% (constant power)
efficiency factor at max. current:	>85%
ripple	max 300mV ptp at 100Hz and 30kHz
software-version date	UPE4000 V2.2 dated 01.12.2008
electrical safety:	According to EN 60950
EMC:	Acc. to VG95373-GwK3, EN50081-1, EN55022, EN61000-3-2, EN61000-3-3, EN50082-2, EN 61000-4-2, -3, -4, -5, -6, -11, EN50204, EN61131-2
vibration / shock	MIL STD 810 E/F method 516.4/5 procedure I
operating range above datum line	0 to 3000m
temperature range in use °C	-20 to +50
temperature range storage °C	-30 to +70
safety class:	IP54

1.5.5. Display and functional tests

The display UPS is located on the heat sink protected by a solid foil.

The battery voltage is shown on the display by pressing the keyboard switch (11) at any time before the startup of the device.

The current voltage of the battery is shown on the display.

A charged battery should have a minimum off-load-voltage at least of 25,4V.

If the voltage after charging by the built-in battery charger is below 25V after about 1 hour after the charging process is finished use the tester BT2404 for a capacity test.

The illumination of the display stops after 15 seconds if voltage is 26,4V or less for saving battery capacity. It is not necessary to put the power circuit breaker in position „On“ for showing voltage.

1.6. Portable box LOWER part

1.6.1. Operating range

The portable box is made of stainless steel powder-coated from the in- and outside. The colour used is RAL7013.

The portable box is PE-foam-coated from the inside with PF 571.

The foam protects the batteries from shock and vibrations in daily use.

The portable box stays on solid rubber feet when put on the ground.

The batteries are mounted in the LOWER part of the portable box shock-resistant.

The lower part of the device consists of the following components:

1 portable box - steel-A2 - powder-coated

4 rubber feet with integrated vulcanised steel plates

5 PE-foam elements self-adhesive for the inside of the portable box

1 battery bail with cable clip

1 thermistor cable

1 battery set consisting of 2 × A512 16Ah

1 battery connection set

1 battery connection cable

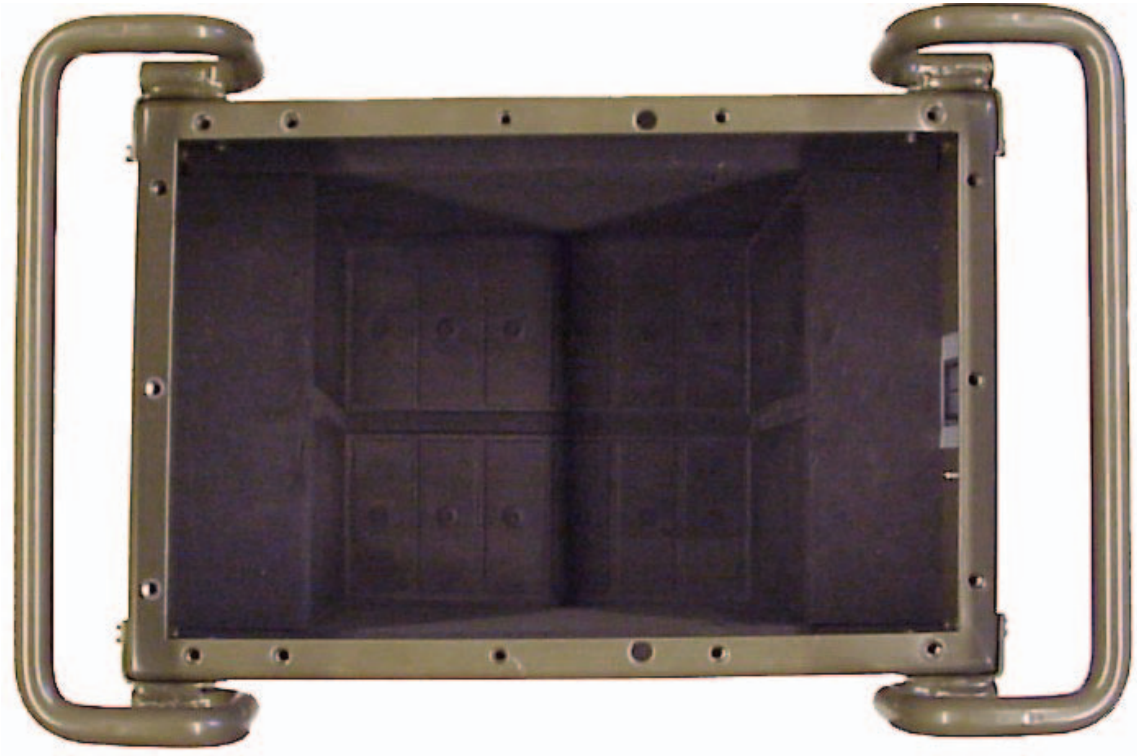

Pic. 5: Portable box LOWER part without batteries view from top

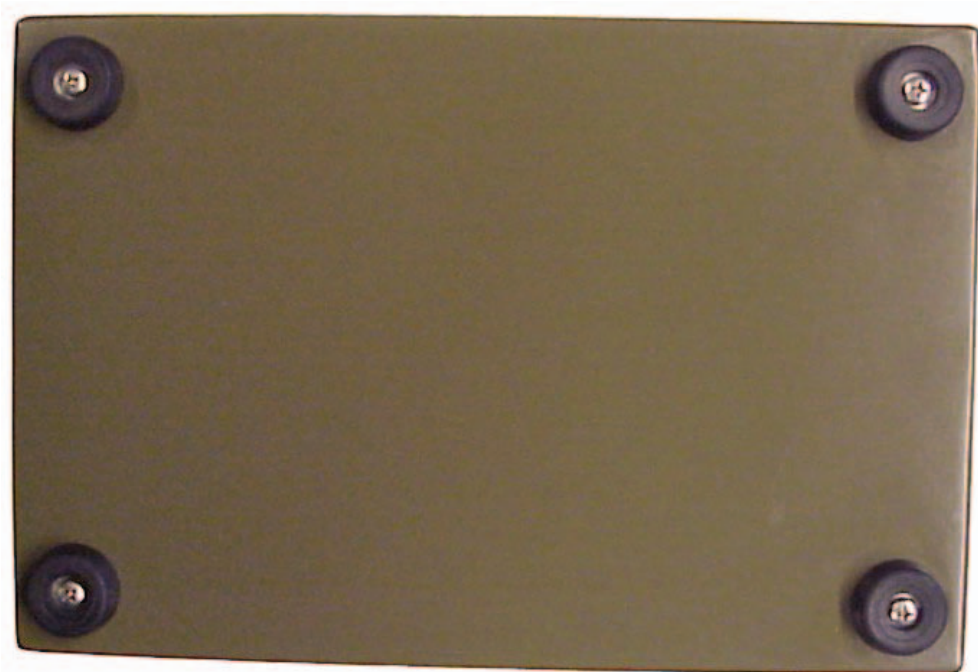

Pic. 6: Portable box LOWER part without batteries view from the bottom

The LOWER part of the device is waterproof which is necessary for the use in open field when the device stands in water.

The transportation handles are screwed on the portable box and are available as spareparts in case they are damaged.

1.6.2. Electrical function

Within the portable box foam-coated 2 sealed GEL-batteries 12V 16AH, type Sonnenschein A512 / 16,0 G5 are amounted in serial operation.

The batteries are fixed with a U-shape bracket so that they can not move inside the device in case the UPE4000 is thrown to the ground.

The battery-connection-cable is contacted to the power unit via a 2-pole connector in series via connection with a nickel-plated copper bridge.

A thermistor cable is fixed between the batteries with a plastic clip to the bail. The other side is clipped to the power board.

Thus the power electronics gets reliable information about the battery temperature.

The charging software secures that the battery voltage corresponds to the temperature of the batteries. The battery is charged optimal at a temperature range between -20° and $+70^{\circ}$ Inside the smaller front of the portable box a PE-screw is fixed.

ATTENTION

After changing the batteries please check that the green/yellow ground cable between PE-screw and UPPER part of the device has been fixed.

In case of electrical disturbances the BOTTOM part of the portable box must be grounded!

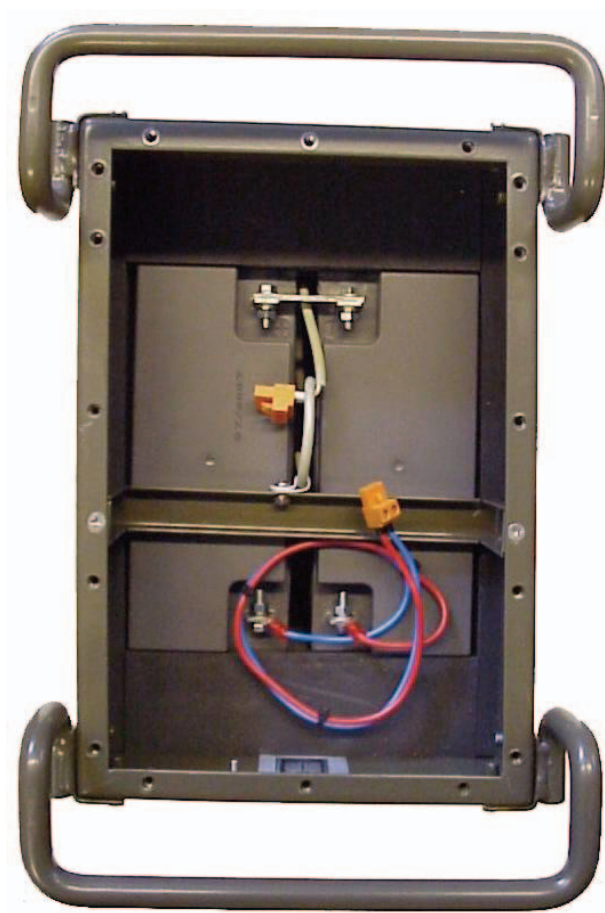

Pic. 8: Portable box including batteries

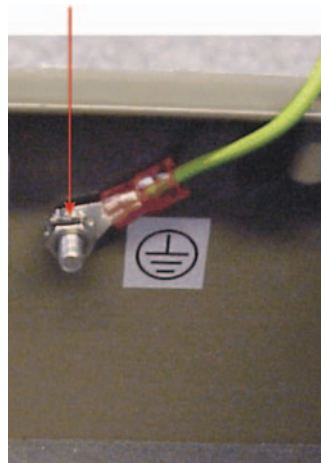

Pic. 7: PE-Connector within portable box LOWER part

1.7. Portable box UPPER part

1.7.1. Operating range

The UPPER part of the device is fixed to the LOWER part of the portable box with 16 allen screws size M4 x 20 with a rubber seal in between.

The UPPER part of the device is a heat sink.

The heat which can develop on the boards on the inside of the UPPER part will be drained convective via the heat sink.

On the UPPER part of the UPE4000 all connectors and display elements as well as the ventilation of the LOWER part of the device are mounted. The UPE4000 conforms in minimum to protection class IP54 if dust protection caps are mounted. The device has got a ventilation screw which drains dangerous detonating gas which could develop if the battery charger or the battery itself is defect.

1.7.2. Electrical functions

Following components are mounted on the UPPER part:

- (1) Power inlet fuse F1: T2A inside the device on the power board
- (3) Safeguarding output / input External Charge F3: T10A inside the device on the display board T10A (self resetting)

- (1) Power inlet fuse F1
- (2) Fuse F2 protecting mobile radios output
- (3) Fuse F3 protecting battery input / output
- (4) Ventilation screw
- (5) Mains lead with cable gland
- (17) PCB with connectors RFE/BBE and COT
- (18) Connector battery
- (9) PE-screw with marking
- (10) Power circuit breaker output RFE/BBE
- (19) Display board
- (20) Power unit
- (14) Serial number UPPER part of the device

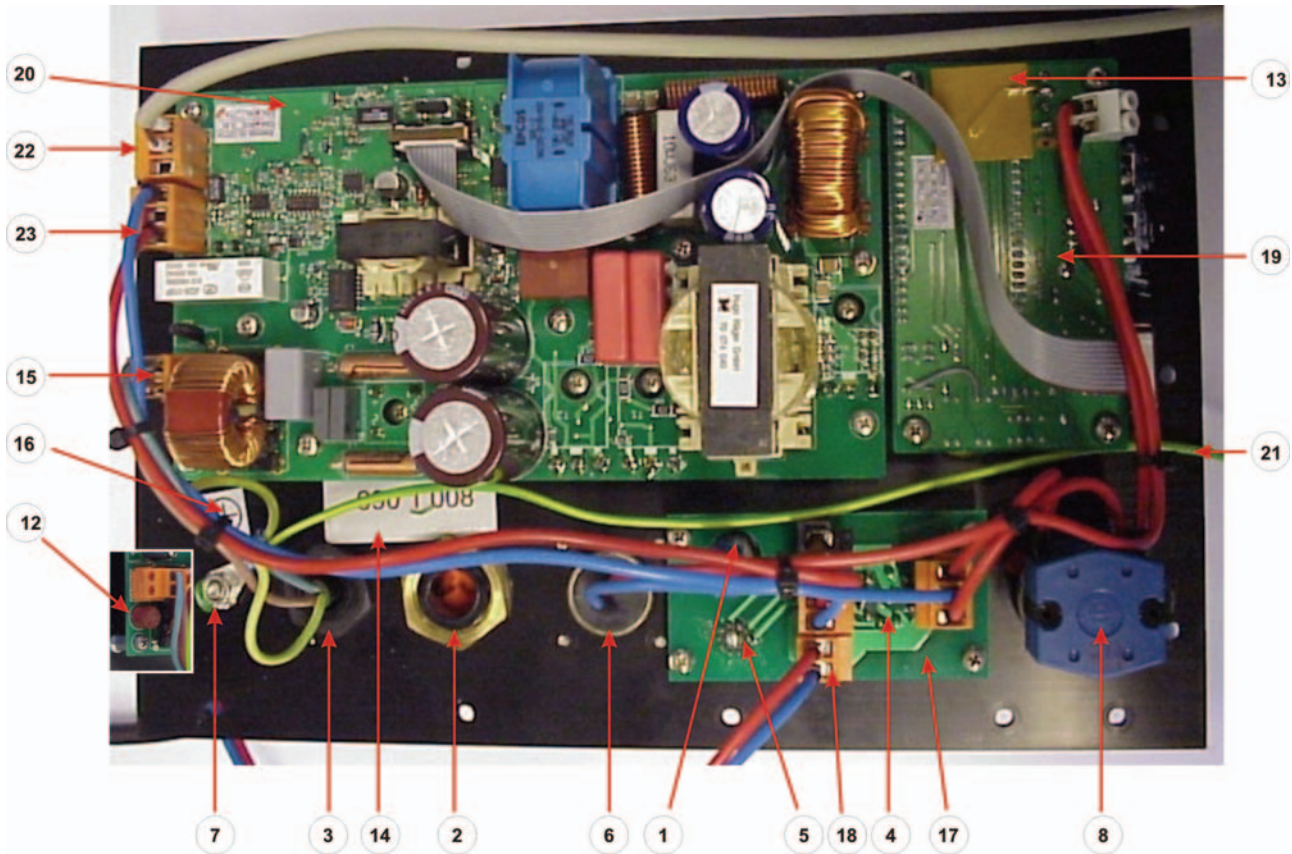

Pic. 9: Portable box UPPER Part view from below

1.7.2.1. Power inlet fuse F1(1)

The power inlet fuse is mounted on the power unit next to the 2-pole plug-connector which is used for the netcable. The micro-fuse is dimensioned 250V T2A which will be changed using needle nose pliers and soldering iron.

1.7.2.2. Fuse F2 mobile radios output (2)

The mobile radio outlet RFE/BBE is protected with a glass fuse 20mm T10A. This fuse can be reached from the outside. Using a screwdriver size 2 you can open the fuse holder.

1.7.2.3. Fuse F3 battery input / output (3)

A 2-pole trickle charging socket according to VG 95234A16S-4SN is used for the connection to external batteries or other DC-elements such as charger or fuel cells. If necessary other devices introduced to ÖBH such as EL11 or UL30 can be connected to the UPE4000 without any additional effort. This charger input can be used as outlet as well because the fuel cell needs a counter-voltage for startup. This input/output is protected with a self resetting polyswitch fuse of 10A which is mounted on the display board into the positive line of the plug.

1.7.2.4. Ventilation screw (4)

In case of a defect battery (i.e. a defect cell) the remaining cells get an overload. Using sealed batteries this will lead to the opening of the valves.

Detonating gas (hydrogen and oxygen) is leaking. If the concentration of the gas is high a spark might be enough i.e. a relay switching operation to initiate an explosion which damages at least the UPE4000.

This is the reason why the UPE4000 includes a ventilation screw which enables the escaping of the gas.

1.7.2.5. Mains lead with cable gland (5)

The netcable 5m is implemented in the device via a waterproof cable gland.

The gland is funnel-shaped to avoid snapping off the rubber main.

The PE-lead of the net-cable (green/yellow) (6) will be fixed at (9) with cable (21).

1.7.2.6. PCB with connectors RFE/BBE and COT (7)

The mobile radio plugs RFE/BBE and COT are waterproof screwed to the UPPER part of the UPE4000. For undisturbed data transfer the contact females are soldered to the board.

1.7.2.7. PE-screw (9) with marking (16)

The ground connection protects the UPE4000 when used in open field against dangerous overvoltage i.e. stroke of lightning. The ground cable of minimum 4mm² will be fixed with the knurled nut using a cable shoe M5.

1.7.2.8. Power circuit breaker output RFE/BBE (10)

The power circuit breaker „Battery Output On“ which conforms to protection class IP54-leads the battery voltage on the output RFE/BBE. The output is dimensioned for a current of 10A.

1.7.2.9. Display board (19)

The display board contains the display and the associated foil pushbutton for activating the display. Two voltage regulators supply the unit. On the board a beeper is integrated (alarm for power sag). The self-resetting fuse F3 is easily changeable. It is integrated into the plusline of the charging socket (8).

1.7.2.10. Board power unit (20)

The power PCB includes the pulse width modulated from power unit and the processor part for controlling the whole UPE4000. All control components are done in SMD technique.

The power components are soldered conventionally in wired technique.

The thermistor cable (12), the mains lead (15) and the battery connection cable (13) are positioned on the PCB.

1.7.2.11. Series number UPPER part of the device (14)

At first delivery of the UPE4000 the device numbers for the UPPER and the LOWER part of the device are identical. For repair at the suppliers premises it is sufficient to send in the UPPER part of the UPE4000. Technically it is irrelevant which LOWER part is mounted to which UPPER part. After repair the serial number helps matching the original set; although technically not mandatory.

1.8. Display

1.8.1. Display without power supply line

Without mains only battery voltage is shown on display. After actuating display by push-button (11) the illuminated display shows:

UPE4000 2.1

A short time later:

Battery ok
25,4V 0.0A

The display dies out after 15 seconds. ($V_{\text{Batt}} < 25,4 \text{ VDC}$)

1.8.2. Display with power supply line

A sound signal starts as soon as the mains lead is enrolled from the transportation handles and the SCHUKO-plug is plugged in.

UPE4000 2.1
25,4V 0.0A

The microprocessor checks if a chargeable battery is available and starts the charging routine.

The mode which is used depends on the state of the battery, possible routines:

Battery activation	Precharge 28,8V 1.0A
Main charge I	I-Charge 25,8V 8.0A
Main charge II	U-Charge 28,8V 2.10A

After charging current is below 1A the device starts with military battery maintenance. (saw tooth procedure)

The battery voltage is checked by the microprocessor.

Supervising phase	Supervision 27,7V 0.0A
--------------------------	---

If the voltage falls to 25,6V the power supply starts and charges the battery with 1A until the turn-off voltage of 28V is reached.

Trickle phase	Supervision 27,7V 1.0A
----------------------	---

This routine can be repeated over and over again while keeping the UPE4000 on the net without damaging the battery.

2. Operation and maintenance

2.1. Start-up

The device will be connected as follows:

Check battery sets while pressing key DISPLAY

Enrol net cable and put into socket 230VAC 50 Hz

Connect ground cable

Connect mobile radio to RFE/BBE

Connect handling unit to COT

2.2. Display of faults

Display of faults UPE4000

Re- port No.	Where	Description of faults	Cause	Action
1	Display	no Batt.	battery not available	mount battery
2	Display	FAILURE BATTERY	Temp of battery over 70 °C	Wait until battery has cooled down and start loading again. Check batteries.
3	Display Sound signal	Mains fails is beeping	The power plug or the external power supply are not connected	Press key to end sound signal
4	Display	Battery low	Battery voltage below 21,6 V	Take off consumers which are not needed because the battery will be empty soon
5	Display Sound signal	SWITCH OFF is beeping	Battery voltage below 20,4 V	Switch off UPE 4000 or connect the AC-net because battery is empty.

2.3. Maintenance

The device needs no special care or maintenance.

For dirt on the powder coated parts just use a wet towel for cleaning eventually use soft detergents and a soft brush (i.e. brush for dish washing).

Dirt on plugs or gills blow out with compressed air.

2.4. Stop operation

Existing net

If UPE4000 is not in use it is not necessary to separate UPS and battery. The power circuit breaker should be positioned in the middle. The trickle charging process allows to remain on the net as long as you like.

2.5. Net not available

If no power supply line is available the dryfit batteries can be kept in the device for 2 years without recharging without deep discharge in case the storage started with full batteries. The electronics for supervising the external charge plug needs a permanent current of 35mA which is less than the normal self discharge of the battery.

For recharging the battery connect the power plug when net is available.

3. Maintenance and repair A1 and A2

3.1. Maintenance and repair Level A1

3.1.1. Repair Level A1 dust hood and fuse

Tools:

slotted screwdriver size 1×6×150 (PH 1)

Phillips-tip screwdriver size 2 (PH 2)

In general the device needs no maintenance. The user is authorised to change mechanically destroyed dust cap of the connecting elements RFE/BBE and „External Charge“ as well as COT. At RFE/BBE and „External Charge“ the connecting screw of the security cord will be unscrewed and the dust cap will be fixed by using a Phillips-tip screwdriver PH2. At the COT the fixation cord of the old dust hood has to be removed by cutting with scissors. The cord of the new dust hood will be lead through the loop of the plastic washer on the bottom of the plug and securely knotted. In case of too high output power (>10A) at the plug RFE/BBE - caused by a defect mobile radio – the fuse can be changed using a slotted screwdriver. For the changing of all other elements the device has to be opened. These repairs are only permitted by trained personnel higher than level A1.

3.1.2. Repair Level A1 feet of portable box

Tools:

Phillips-tip screwdriver size 2 (PH 2)

In case of damaged feet of the device turn the device and put the transportation handles on a soft surface. The batteries are leak safe. Change the damaged feet with a Phillip-tip screwdriver.

3.1.3. Repair Level A1 transportation handles

Tools:

allen wrench size 3

The transportation handles can easily be changed when damaged because of fall. Unscrew the 2 transportation handles by taking the 4 allen screws M4×20 out and put the new handles on in reverse order. It is recommended to put in all screws at first and fix them afterwards.

This procedure avoids damages on the rivet nuts.

3.1.4. Repair Level A1 check batteries

Tools:

Tester BT2404

If the autonomy time of the UPE4000 of minimum 2 hours can not be reached anymore or the battery voltage after charging decreases too soon below 25,4 V the batteries are de-

fect. The batteries can easily be checked using the Tester BT2404. Connect the Tester to the socket "External Charge".

The discharging unit stresses the batteries with the current I_5 . The built-in processor measures the capacity which has been taken and shows the following results:

Battery ok or battery defect

3.1.5. Repair Level A1 change batteries

Tools:

allen wrench size 3

2 screw-wrench 8

Phillips-tip screwdriver size 2 (PH 2)

forceps or needle nose pliers

Change the battery set as follows:

CAUTION

Take out power plug!

Unscrew the 16 allen screws of the UPPER part of the UPE4000.

Take of the UPPER part of the device and lay down next to the LOWER part of the device.

Take out the 2-pole plug of the battery connection cable (13) from the plug board.

Take out the 3-pole plug of the thermistor (12) from the power board.

Unscrew the PE-screw from the PE-cable in the LOWER part of the device using a wrench size 8. This is not really necessary but reliefs the changing of the batteries.

Now the UPPER part of the device is freemoving.

Unscrew the battery bail using a Phillips-tip screwdriver.

Take the bail out of the device by carefully moving and shifting.

Leave the thermistor on the bracket.

Untighten the battery connector using 2 wrenches size 8.

Take out the rubber distance piece – between the batteries – using a forceps or needle nose pliers.

Put the LOWER part overhead and move it back and forth to get the batteries out.

Take the battery connector and the battery connection cable of the defect batteries and mount it to the new batteries.

Fix the battery cable tight on the new batteries.

ATTENTION

Fix the battery connector tight AFTER the batteries have reached their position in the LOWER part of the device.

Putting the new batteries in the device procede in reverse order to the above mentioned steps.

Make sure that you put the batteries in in the right direction because of the cable length.

Look at the picture inside the portable box (Pic. 7)

CAUTION

Screw the PE-main with new external teeth lock washer on the PE-screw tight!

Mount battery connection cable and thermistor on UPPER part.
Mount UPPER part with hermetic rubber seal.

3.2. Additional repairs

Possible additional repairs:

- Replace netcable
- Replace net input fuse
- Replace ventilation screw
- Replace plug connector External Charge
- Replace fuse holder
- Replace power circuit breaker
- Replace display board
- Replace pushbutton
- Replace power unit
- Replace plug board

These repairs are only allowed to higher maintenance levels.
Procedures for these repairs are described below.

3.3. Replacement of consumables, Level A2

The following repairs are permitted:

- Replace connector External Charge
- Replace fuse holder
- Replace netcable
- Replace power circuit breaker
- Replace ventilation screw
- Replace ground connection

The procedure for repairing the parts is described on the following pages.

3.3.1. Repair of connector External Charge

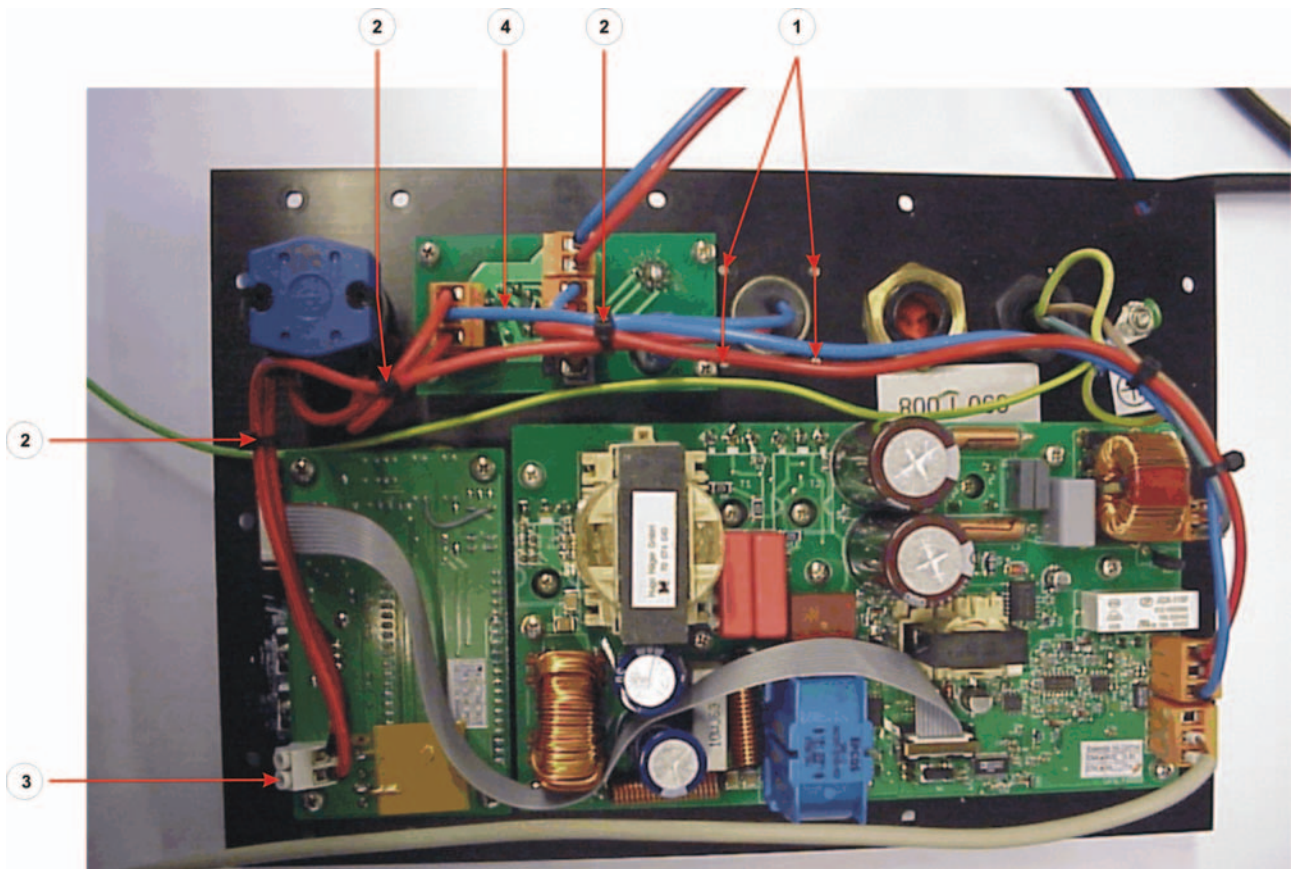

Pic. 10: Upper Part of device view inside

Tools:

- Phillips-tip screwdriver size 2(PH 2)
- slotted screwdriver 0,5×3,5×100
- slotted screwdriver 0,5×2,5×100
- allen wrench size 3
- wire cutter

Unscrew the UPPER part from the portable box to be able to repair the device.

For details please read 3.1.5.

Unscrew the 4 mounting screws (1) on the outside.

Rip the cable binder (2) by using the wire cutter.

Unscrew the + electric main from the clamp gantry (3) of the display board by using the slotted screwdriver 2,5mm.

Unscrew the - electric main from the 3-pole plug (4) of the display board by using the slotted screwdriver 3,5mm. Now you can change the VG-plug. For mounting the new connector repeat the above mentioned steps in reverse order.

ATTENTION

Do not forget hermetic seal under the plug

3.3.2. Replace fuse holder



Pic. 11: Fuse holder

Tools:

needle nose pliers

pipe wrench wrench width 14

allen wrench size 3

Unscrew the UPPER part from the portable box to be able to repair the device.

For details please read 3.1.5.

Unscrew the clamp nut at the outside.

Take off the cable and take out the fuse holder.

The fuse holder can be changed.

Close the device by repeating the steps in reverse order.

3.3.3. Replace netcable

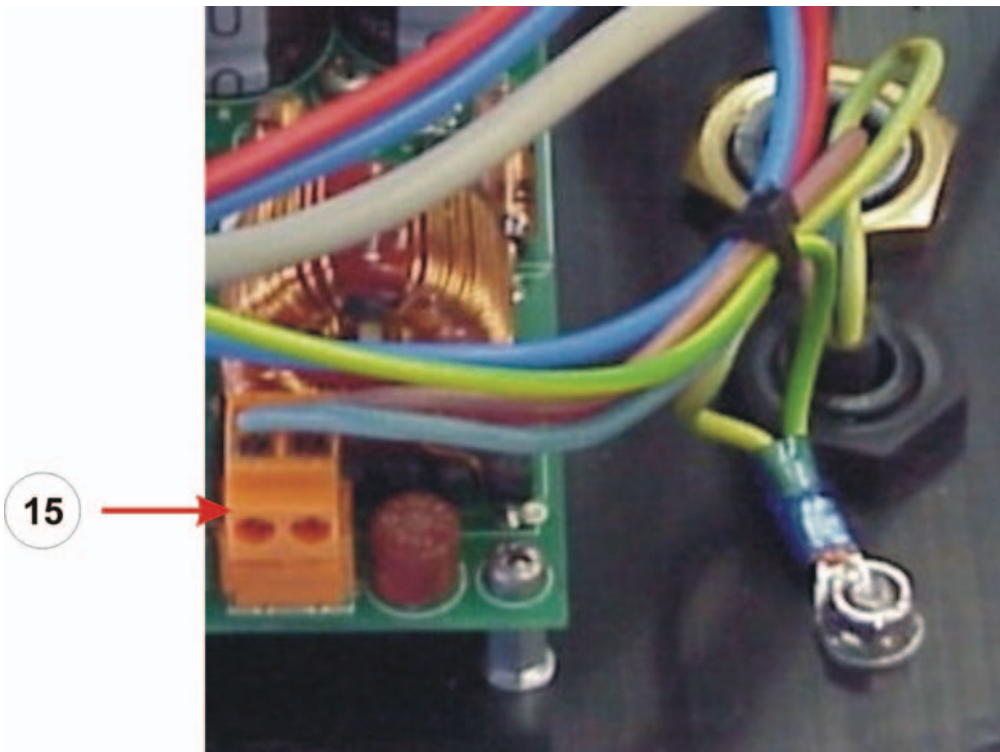

Pic. 12: Netcable

Tools:

- open-end wrench width 18
- combination wrench width 8
- wire cutter
- screwdriver 3,5
- allen wrench size 4
- crimping pliers for ring cable shoe
- allen screwdriver size 3

Unscrew the UPPER part from the portable box to be able to repair the device.

For details please read 3.1.5.

Unscrew the clamp nut at the outside.

Unscrew the cable at the 2-pole plug (15).

Keep the allen screw (9) in position with the allen wrench and unscrew the nut M5 of the ground cable.

Nip off the ring cables shoe and take the cable out.

Put in a new cable and a ring cables shoe M5 and fix it on both ground cables (ground netcable and ground cable of the device) by crimping.

Put the ring cables shoe and the external teeth lock washer on the earth bolt and tie it up by using combination wrench 8mm.

For doing this hold the allen screw tight with the allen wrench.

Screw the brown and blue cable at the orange colored plug(15).

3.3.4. Replace power circuit breaker

3.3.4.1. LOWER part power circuit breaker

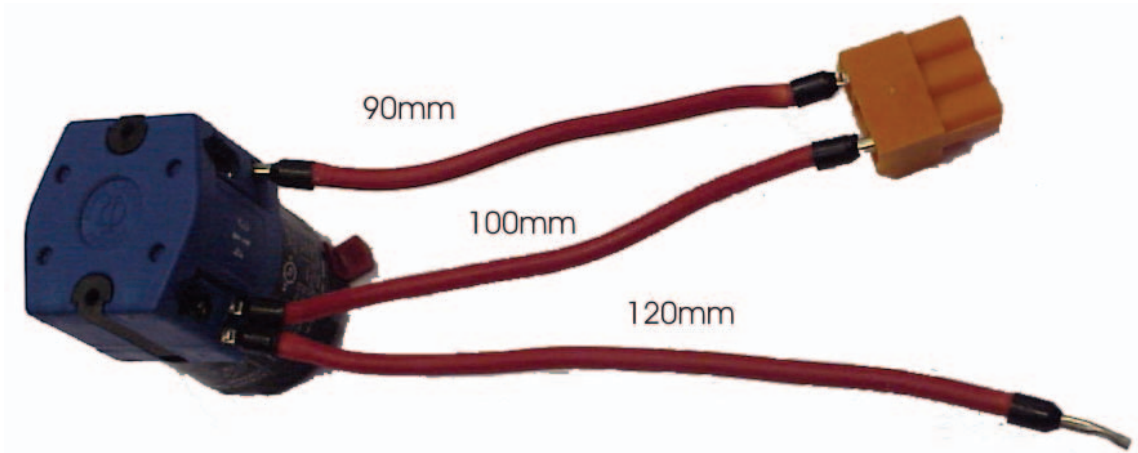

Pic. 13: LOWER part power circuit breaker

Tools:

allen wrench size 3

screwdriver 2,5

Unscrew the UPPER part from the portable box to be able to repair the device.

For details please read 3.1.5.

Unscrew 3 cables from the blue bottom part.

Move the red lever.

Take off the switch and put on a new one.

Reset the red lever and mount the cable (see Pic. 13).

3.3.4.2. UPPER Part power circuit breaker



Pic. 14: UPPER part power circuit breaker

Tools:

allen wrench size 3

open-end wrench 17 mm

Unscrew the UPPER part from the portable box to be able to repair the device.
For details please read 3.1.5.

Move the red lever.
Take of the LOWER part.
Unscrew UPPER part with open-end wrench width 17.
Put on new UPPER part.
Reset the red lever.

3.3.5. Replace ventilation screw

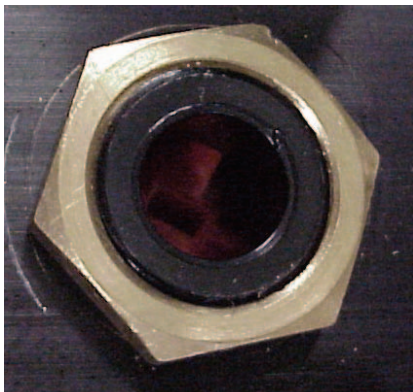

Pic. 15: Ventilation screw inside

Tools:
allen wrench size 3
open-end wrench wrench-width 27

Unscrew the UPPER part from the portable box to be able to repair the device.
For details please read 3.1.5.
Unscrew the counter locknut nut with wrench width 27 and screw out the ventilation screw.
You might need an additional claw for taking it out.
Mount new ventilation with screw-nut.

3.3.6. Replace ground connector

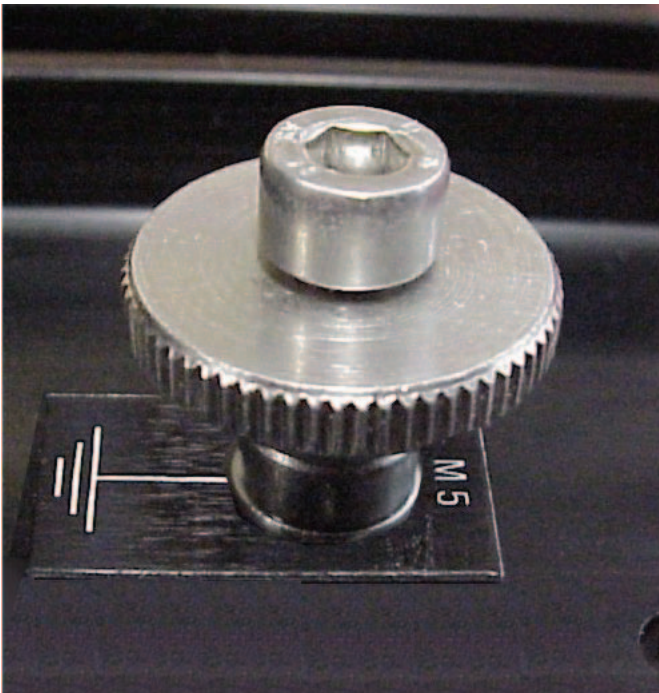

Pic. 16: Ground connector screw

Tools:

combination wrench wrench-width 8

allen wrench size 4

allen wrench size 3

Unscrew the UPPER part from the portable box to be able to repair the device.

For details please read 3.1.5.

Fix the allen screw (9) with the allen wrench and unscrew the nut M5 from the ground cable.

Take off ring cables shoe.

Unscrew allen screw.

Mount new ground connector screw. Take care that the label „ground,, is in the right position.

Put ring cables shoe and external teeth lock washer on earth bolt by using wrench 8mm.

While doing this fix the allen screw with the allen wrench.



Pic. 17: Special Tool COT (Bernier)



Pic. 18: RFE/BBE connector

4. Additional repair higher than Level A2 (depot and industry)

Additional repairs such as the maintenance of the display and the change or repair of the power board is only permitted to especially trained personnel or by the supplier.

4.1. Replace plug board

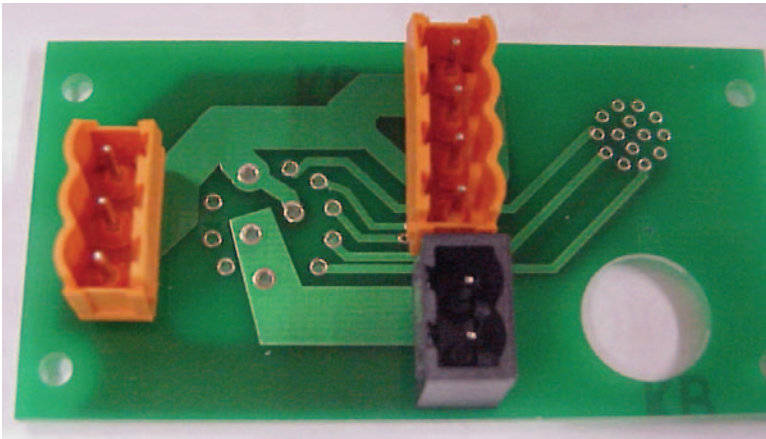

Pic. 19: Plug board without connectors

Tools:

- allen wrench size 3
- open-end wrench width 5,5
- Phillips-tip screwdriver size 1 (PH 1)
- wire cutter
- needle nose pliers
- soldering iron
- exhaust pump
- special Tool COT (Bernier)

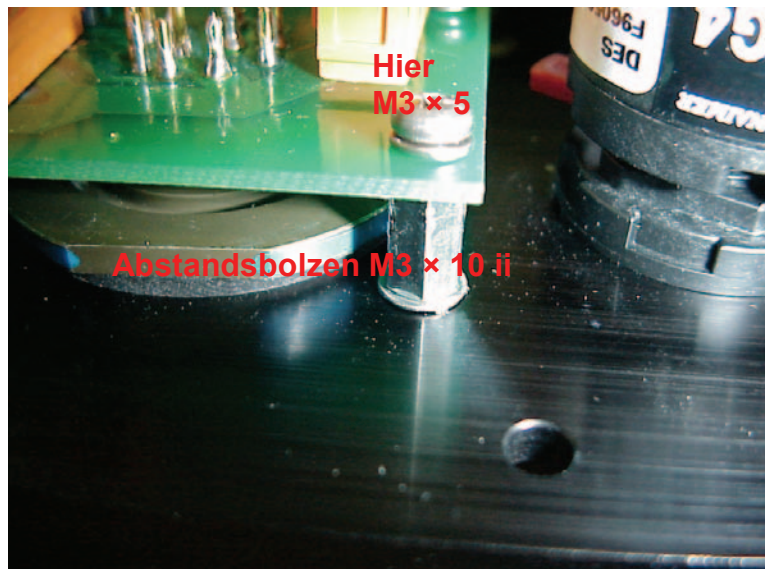

Pic. 20: Plug board fixation

Unscrew the UPPER part from the portable box to be able to repair the device.

For details please read 3.1.5.

Unscrew the plug COT from the heat sink with a special tool.

Unscrew the nut of the plug RFE/BBE from the upper part of the heat sink with socket wrench 34mm.

Take off plugs coloured orange and brown.

Unscrew the 4 phillips-tip screws which are used for fixing the distance bolts on the plug board. Take off the plug board including plug. Move the board backwards and forwards for taking out because the plugs can be canted with the heat sink.

Mount a new board with plugs. Make sure that the plug RFE/BBE contains a blue and a black seal (see Pic. 18). Underneath the plug COT is a blue seal.

Mount the board with 3 screws M3 × 6 and 1 screw M3 × 5 (see Pic. 20).

Mount dust hood on plug COT.

Screw nuts RFE/BBE and COT. Put plug in again.

4.2. Repairs on the display PCB

4.2.1. Replace display board

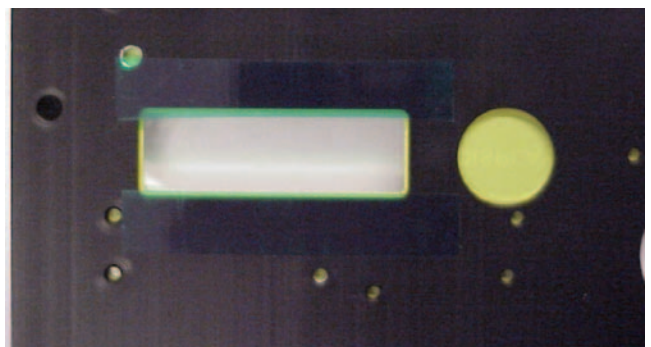
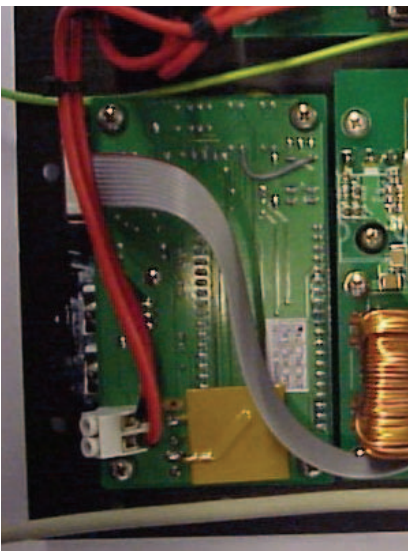

Pic. 21: Insulation tape on the rear side of the display

Pic. 22: Display board

Tools:

Phillips-tip screwdriver size 1(PH 1)

slotted screwdriver 2,5

allen wrench size 3

slotted screwdriver 3,5 mm

forceps

Unscrew the UPPER part from the portable box to be able to repair the device.

For details please read 3.1.5.

Unscrew 4 phillips-tip screws

Unscrew the 2 slotted screws of the voltage regulators.

Unscrew flat cable and battery cable

Take care that the insulation tape on the heat sink will not be damaged (see Pic. 21)

Put on new board

Make sure that the 4 distance bolts are fixed correctly and the insulation plate (AIO) will not be damaged. (see Pic 22)

Fix the screws tight.

Make a functional test of the pushbutton (is clicking when pressed).

Screw flat cable and battery cable.

Outside Pin leads to external charging socket „External charge“ (8), inside Pin to power circuit breaker ((10) Pic. 9 page 20).

4.2.2. Replace push-button

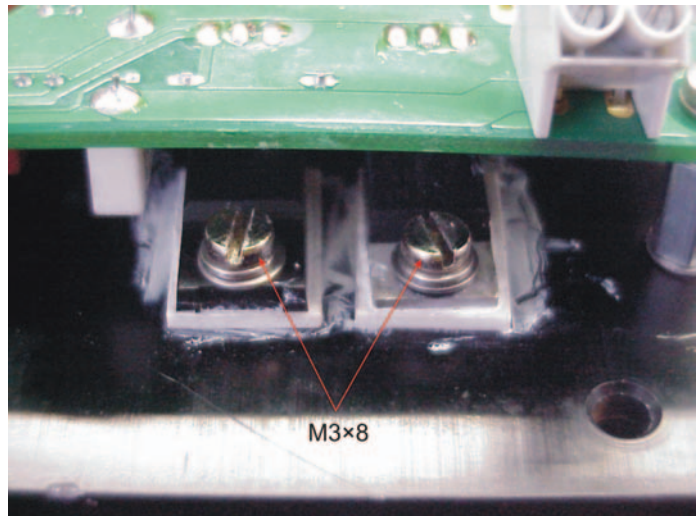

Pic. 23: Constant voltage regulators

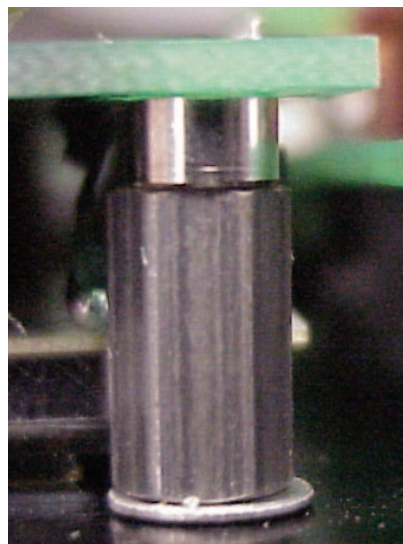

Pic. 24: Distance rolls

Tools:

Phillips-tip screwdriver size 1(PH 1)

slotted screwdriver 2,5

Allen wrench size 3

forceps

soldering iron

Unscrew the UPPER part from the portable box to be able to repair the device.

For details please read 3.1.5.

Unscrew 4 screws.

Unscrew the 2 slotted screws of the voltage regulators.

Unscrew the flat cable and the battery cable. Take care that the insulation tape on the heat sink will not be damaged (see Pic. 21)

Solder out pushbutton and solder a new pushbutton in.

Mount board.

Make sure that the 4 distance bolts are fixed correctly and the AIO-plates will not be damaged. (see Pic. 23)

Fix the screws tight.

Make a functional test of the pushbutton (is clicking when pressed).

Screw flat cable and battery cable.

Outside Pin leads to external charging socket „External charge“ (8), inside Pin to power circuit breaker ((10) Pic. 9 page 20).

4.2.3. Change display

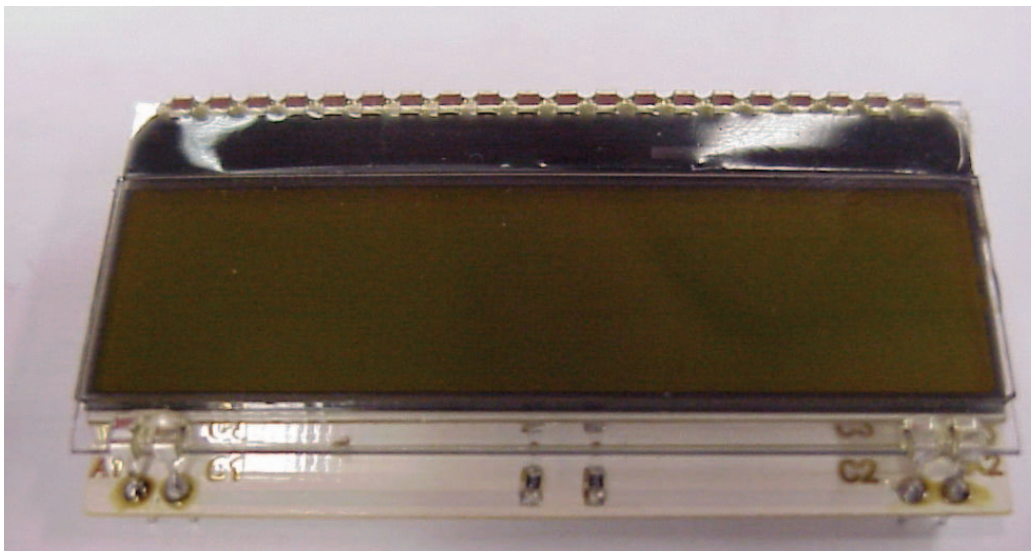

Pic. 25: Display

Tools:

Phillips-tip screwdriver size 1(PH 1)

slotted screwdriver 2,5

allen wrench size 3

forceps

Unscrew the UPPER part from the portable box to be able to repair the device.

For details please read 3.1.5.

Unscrew 4 screws.

Unscrew the 2 slotted screws of the voltage regulators (see Pic.: 22).

Unscrew the flat cable and the battery cable. Take care that the insulation tape on the heat sink will not be damaged (see Pic. 20).

Pull out display and replace it with a new display.

Put on board.

Make sure that the 4 distance bolts are fixed correctly and the AIO-plate will not be damaged (see Pic 22).

Fix the screws tight.

Make a functional test of the pushbutton (is clicking when pressed).

Screw flat cable and battery cable.

Outside Pin leads to external charging socket „External charge“ (8), inside Power circuit breaker to plug ((10) Pic. 9 page 20).

4.3. Replace power board

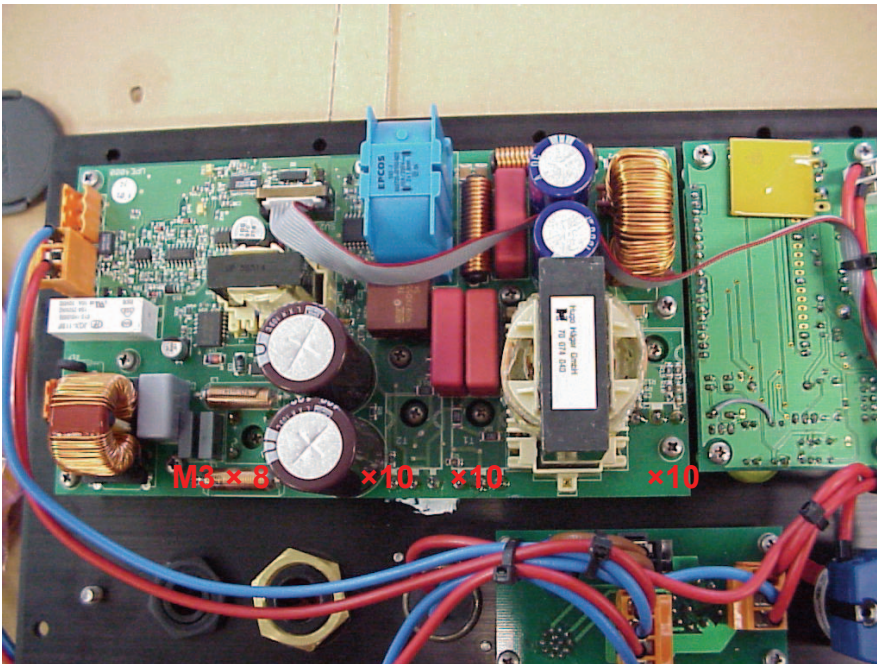

Pic. 26: Power board view from above

tools:

Phillips-tip screwdriver size 1(PH 1)

allen wrench size 3

Unscrew the UPPER part from the portable box to be able to repair the device.

For details please read 3.1.5.

Unscrew 12 screws.

Pull off flat cable

Pull off plug coloured in orange

Put on new board

Take care that all 4 power components are in the right position on the heat sink.

Use thermal grease underneath.

Screw board.

Put on flat cable.

Put in plug coloured in orange.

Put on thermistor on the 3-pole connector.



Pic. 27: Main electronic components on power board on heat sink

5. Spare parts

Main electronic components

No		Subject	Storage number	Nato stock No.
0	UPS completely equipped with 2 batteries	Portable power supply UPE4000 Main electronic components –0	UPE4000	6130-41-000-5114
1	Portable box bottom part without batteries	Portable power supply UPE4000 Main electronic components –1	UPE4000-001	
2	Battery set ready for installation	Portable power supply UPE4000 Main electronic components –2	UPE4000-002	
3	Portable box UPPER PART part ready for use	Portable power supply UPE4000 Main electronic components –3	UPE4000-003	
4	Operating instructions D	Portable power supply UPE4000 Main electronic components –4	315 069 001 001	
5	Operating instructions E	Portable power supply UPE4000 Main electronic components –5	315 069 002 001	
6	Operating instructions F	Portable power supply UPE4000 Main electronic components –6	315 069 003 001	
7	Operating instructions NL	Portable power supply UPE4000 Main electronic components –7	315 069 004 001	
8	Spare parts catalogue with pictures E	Portable power supply UPE4000 Main electronic components –8	315 069 002 009	

Portable box bottom part without batteries

No		Subject	Storage number	Nato stock No.
1	Bottom part A2, complete including batteries	Portable power supply UPE4000 UPS BOTTOM part - 1	UPE4000-001	
2	Bottom part A2, powder coated, without portable handles	Portable power supply UPE4000 UPS BOTTOM part – 2	108 069 100 001	
3	Set of two transportation handles powder coated to be screwed to portable box	Portable power supply UPE4000 UPS BOTTOM part – 3	108 069 100 002	
4	Foam, self-adhesive, for the inside of the portable box	Portable power supply UPE4000 UPS BOTTOM part – 4	108 069 100 003	
5	Set of 4 feet for portable box	Portable power supply UPE4000 UPS BOTTOM part – 5	108 069 100 004	
6	Battery bail with cable clip	Portable power supply UPE4000 UPS BOTTOM part – 6	108 069 100 005	
7	Flatpacking rubber	Portable power supply UPE4000 UPS BOTTOM part – 7	108 069 100 006	
8	Thermistor	Portable power supply UPE4000 UPS BOTTOM part - 8	309 069 100 007	

Battery set ready for installation

No		Subject	Storage number	Nato stock No.
1	Battery set ready for installation	Portable power supply UPE4000 UPS battery set - 1	UPE4000-002	
2	Battery gas-proof 12V 16A	Portable power supply UPE4000 UPS battery set - 2	A512-16 308 069 200 002	
3	Cell connector CU nickel-plate fixation screws	Portable power supply UPE4000 UPS battery set - 3	308 069 200 003	
4	Battery connection cable UPE4000	Portable power supply UPE4000 UPS battery set - 4	309 069 200 004	

Portable box UPPER part ready for use

No		Subject	Storage number	Nato stock No.
1	Portable box UPPER Part ready for use	Portable power supply UPE4000 Portable box UPPER part -1	UPE4000-003	
2	Heatsink finished, black anodized, front foil	Portable power supply UPE4000 Portable box UPPER part -2	108 069 300 013	
3	Ground connector A2	Portable power supply UPE4000 Portable box UPPER part -3	108 069 300 009	
4	VG Plugconnector External charge complete	Portable power supply UPE4000 Portable box UPPER part -4	110 069 300 008	
5	Dust cap 16S	Portable power supply UPE4000 Portable box UPPER part -5	110 069 300 018	
6	Mil STD Plugconnector RFE/BBE complete	Portable power supply UPE4000 Portable box UPPER part -6	110 069 300 006	
7	Dust cap for RFE/BBE	Portable power supply UPE4000 Portable box UPPER part -7	110 069 300 016	
8	Mil STD Plug connector COT complete	Portable power supply UPE4000 Portable box UPPER part -8	110 069 300 007	
9	Dust cap for COT	Portable power supply UPE4000 Portable box UPPER part -9	110 069 300 017	
10	Equipped board ready for installation	Portable power supply UPE4000 Portable box UPPER part -10	307 069 300 014	
11	Mini fuse AC IN 250VT2A	Portable power supply UPE4000 Portable box UPPER part -11	111 069 300 010	
12	Fuse insert F2 T10A 10er	Portable power supply UPE4000 Portable box UPPER part -12	111 069 300 002	
13	Fuse holder F2	Portable power supply UPE4000 Portable box UPPER part -13	111 069 300 003	
14	Ventilation screw with locknut	Portable power supply UPE4000 Portable box UPPER part -14	308 069 300 005	
15	Fuse self-resetting T10A	Portable power supply UPE4000 Portable box UPPER part -15	111 069 300 004	
16	Display board ready for installation	Portable power supply UPE4000 Portable box UPPER part -16	307 069 300 016	
17	Display 20 × 2 illuminated	Portable power supply UPE4000 Portable box UPPER part -17	101 069 300 021	

5 Spare parts

18	Foil console switch	Portable power supply UPE4000 Portable box UPPER part –18	108 069 300 011	
19	Power unit UPE4000 ready for installation	Portable power supply UPE4000 Portable box UPPER part –19	307 069 300 019	
20	Netcable 5m ready for installation	Portable power supply UPE4000 Portable box UPPER part –20	108 069 300 020	
21	Cable Gland UPE4000 bend protection	Portable power supply UPE4000 Portable box UPPER part –21	103 081 110 012	

Additional equipment

No		Subject	Storage number	Nato stock No.
1	Tester for capacity BT2404	Portable power supply UPE4000 Additional equipment –1	BT2404	
2	Transport Box	Portable power supply UPE4000 Additional equipment –2	108 069 100 101	

6. Documents

Konformitätserklärung Declaration of Conformity



Dokument-Nr.:
Document- No.:

01/08

Hersteller:
Supplier:

Nortec Electronics GmbH & Co. KG
An der Strusbek 32 B
D-22926 Ahrensburg

Tel.: +49 / 4102 / 42002
Fax: +49 / 4102 / 42840
Email: info@nortec-electronics.de

Produktbezeichnung:

Name of product:

UPE4000

Part-No.: UPE4000

Das bezeichnete Produkt stimmt mit den Vorschriften folgender europäischer
Richtlinien überein:

The indicated product conforms to the following regulations of European Council:

EN 60950 et IEC 536

NorTec Electronics GmbH & Co. KG
An der Strusbek 32 B · 22926 Ahrensburg
Tel. +49 4102 42002 · Fax +49 4102 42840

A handwritten signature in black ink, appearing to read 'W. L. Stee', is written over a faint, illegible printed name.

Ahrensburg
28.1.2008

Unterschrift
Signature

EMI TEST - Report

EMV003708e.doc
this report consists of 31 pages

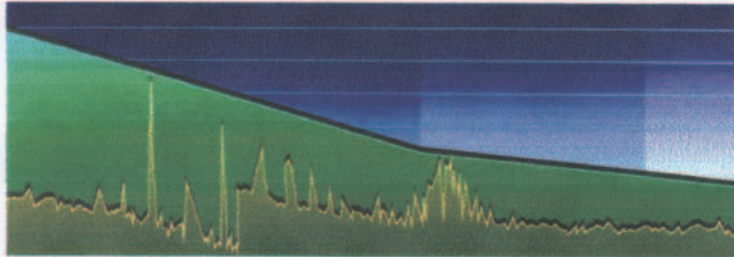

customer : JRR NorTec Reparaturen
An der Strusbek 32B
22926 Ahrensburg

conclusion of test results

Equipment under Test : UPE 4000

SN: 690 001

Tested acc. to : VG 95373

In all emission-/ susceptibility tests *no values were above the limits or malfunctions or degrading of system performance occurred.*

This test report is valid only for the above mentioned equipment. Reproduction or issue to third parties in any form whatever is not permitted without written authority from the EMC test department.

Present : EMC lab. GEDIS: P.Sell Date : 3.03.2008
customer : Mr. Schimmel



GEDIS GmbH
Edisonstr 3 , 24145 Kiel
Tel. 0431 7109 448 Fax . 0431 7109 665

Attention: This certificate is only valid for UPE4000.2 (Version VG95373)



Parc scientifique Fleming
Granbonpré 1
B-1348 Louvain-la-Neuve
T +32 10 47 52 11 - F +32 10 47 52 67
tech@anpi.be - www.anpi.be



Test report No. COM/PX/1855 (draft) - 2008.03.04

Performed at the request of:

JRR NorTec-Reparaturen
An der Strusbek 32B
D - 22926 Ahrensburg
Germany
Tél : +49(0)4102 42002

Tested Objects

<i>Subject</i>	<i>Manufacturer</i>	<i>Product Name</i>	<i>File Number</i>
Uninterruptible Power Supply	JRR NorTEC-Reparaturen	UPE4000	20080044

Test History

Equipment acceptance and delivery of technical file	2008.02.22
Testing Periods	2008.02.22 - 2008.02.25

Standards & Specifications

IEC 60529:2001
Degrees of protection provided by enclosures (IP Code)

This report contains 8 pages.

This report may not be reproduced in part without the written consent of the ANPI laboratories.

Each page of this report bears the red stamp of the ANPI laboratories.

This test report is not a proof for certification and is only valid for the tested products.

Dr B. Stockbroeckx
Head of department EMC & Electrical Safety
Head of division Laboratories





ÉCOLE ROYALE MILITAIRE
LABORATOIRE DYNAMIQUE DES STRUCTURES MÉCANIQUES
Avenue Renaissance 30
B-1000 BRUXELLES



RAPPORT ESSAIS DE VIBRATIONS

LDMS-ES-080211/01

Essais exécutés le 21 février 08

Par

J.F. Herbiet

Rapport rédigé le 10 mars 2008

Nombre de pages: 11